

ADL210 | GENERAL INFORMATION

Linear LED luminaire with knife edge cove extrusion

Project: _____ Type: _____

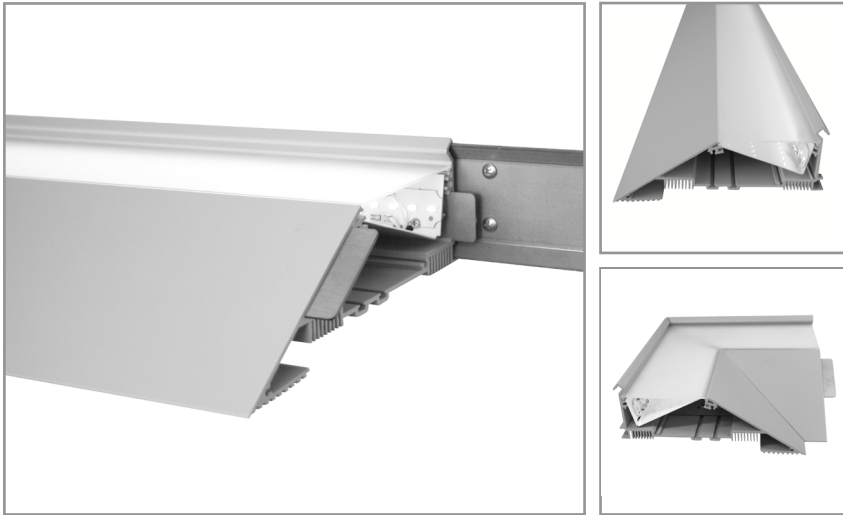

FEATURES

The ADL210 linear LED luminaire features an integrated knife edge cove extrusion. The sharp-edge profile attaches to a heavy gauge, steel hanging channel and accepts 5/8" thick drywall on its underside. 90° corner and field-trimmable fixture options enable the ADL210 to follow typical room perimeters.

SPECIFICATIONS

Fixture comprised of an aluminum extrusion with knife edge profile, high reflectance LED reflector and frosted acrylic dust cover

Knife edge extrusion accepts 5/8" drywall and is finished in primer powder coat

Includes heavy gauge, steel mounting channel

Available in straight lengths of 2'-8' lengths nominal, 90° inside and outside corners and field-trimmable filler lengths

Basic continuous run fixtures provided with 18 ga. wiring harness for 6 Amp maximum load (consult factory for runs requiring greater amperage)

Standard integral 120-277V driver offered with 0-10V dimming or non-dim (other dimming driver options available)

Standard light outputs are 590, 765 or 1000 lumens per foot

LEDs available in 2700K, 3000K, 3500K, and 4000K, within a 3 step MacAdam ellipse, all with 90+ CRI typical

LED life rated at 50,000 hours

Limited five year warranty

UL and C-UL listed for dry and damp locations

IBEW manufactured and assembled

MADE IN U.S.A.

PROFILE

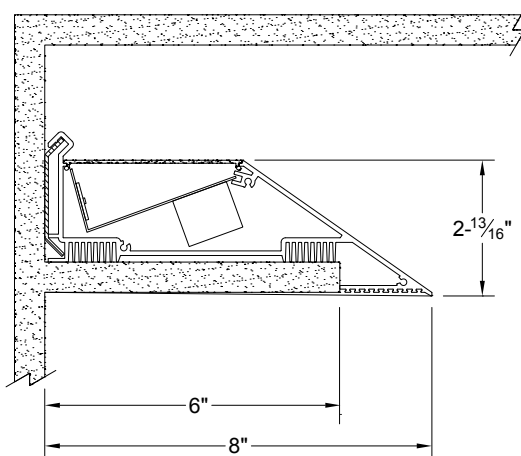

PERFORMANCE

NOMINAL LENGTH	OUTPUT	LUMENS/ft.	WATTS/ft.	LUMINAIRE LUMENS	EFFICACY (LPW)
4'	L: low	590	5.7	2160	103
	R: regular	765	7.9	2805	97
	H: high	1000	11.0	3685	92

Note: All data reflects fixtures with 3500K LEDs

ADL210 -

SHAPE

- 2: straight 22-1/8"
- 3: straight 33-1/8"
- 4: straight 44-1/8"
- 5: straight 55-1/8"
- 6: straight 66-1/8"
- 7: straight 77-1/8"
- 8: straight 88-1/8"
- F1: filler 16-5/8" - 22-1/8"
- F2: filler 22-1/8" - 27-5/8"
- CI: corner inside
- CO: corner outside

CORRELATED COLOR TEMPERATURE

- 27: 2700K-90+ CRI
- 30: 3000K-90+ CRI
- 35: 3500K-90+ CRI
- 40: 4000K-90+ CRI

DRIVER

- [Non-Dimming]**
- leave blank for non-dimming
- [Dimming]**
- D: 0-10V, 1%
- CF: Consult factory for Lutron and eldoLED driver options

LIGHT OUTPUT

- (Lumens per foot)
- L: low - 590
- R: regular - 765
- H: high - 1000
- CF: consult factory for custom output

MOUNT

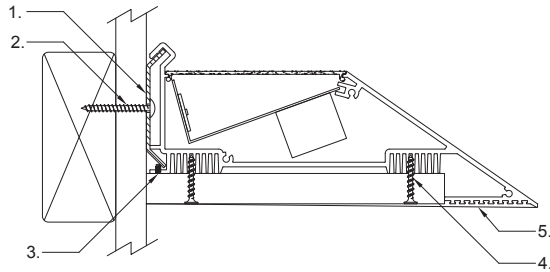

1. Fixture housing hangs on heavy gauge steel channel
2. Channel secured to wall with appropriate fasteners by others
3. Set screw locks fixture housing to the channel
4. Drywall screws affix 5/8" drywall to fixture housing
5. Finished drywall surface

SHAPES

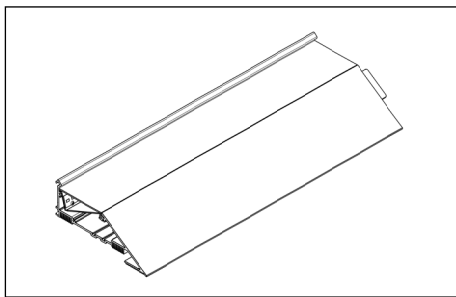

STRAIGHT

- Available in lengths of 22-1/8", 33-1/8", 44-1/8", 55-1/8", 66-1/8", 77-1/8" and 88-1/8"
- Alignment tabs minimize plaster finish work between fixture joints
- Primer powder coat ready to accept wall finish

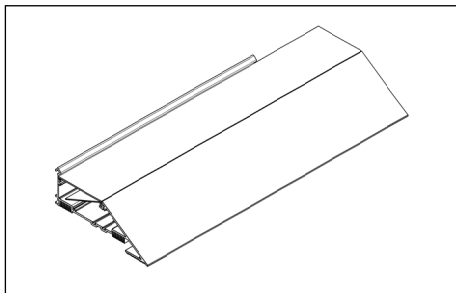

FILLER

- Available in two versions (16-5/8" – 22-1/8" and 22-1/8"-27-5/8") to fill run lengths.
- Extrusion is field-trimmed for a custom fit
- Sliding reflector section adjusts to minimize gap between LED modules (2-1/2" maximum gap at either end)
- Depending on driver option, power is either integral or supplied by adjacent fixture (determined by Bartco Lighting in the quoting stage)

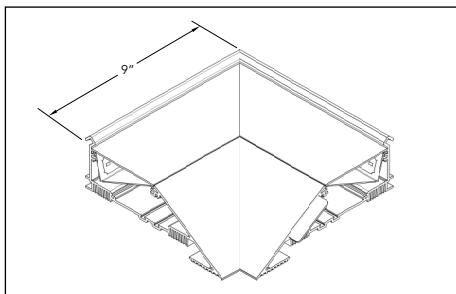

INSIDE CORNER

- Extrusion provided assembled at 90° angle
- Power supplied by adjacent fixture (determined by Bartco Lighting in quoting stage)

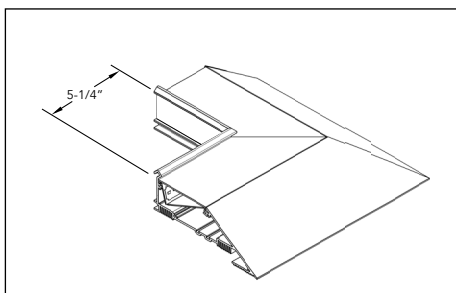

OUTSIDE CORNER

LAYOUT EXAMPLE

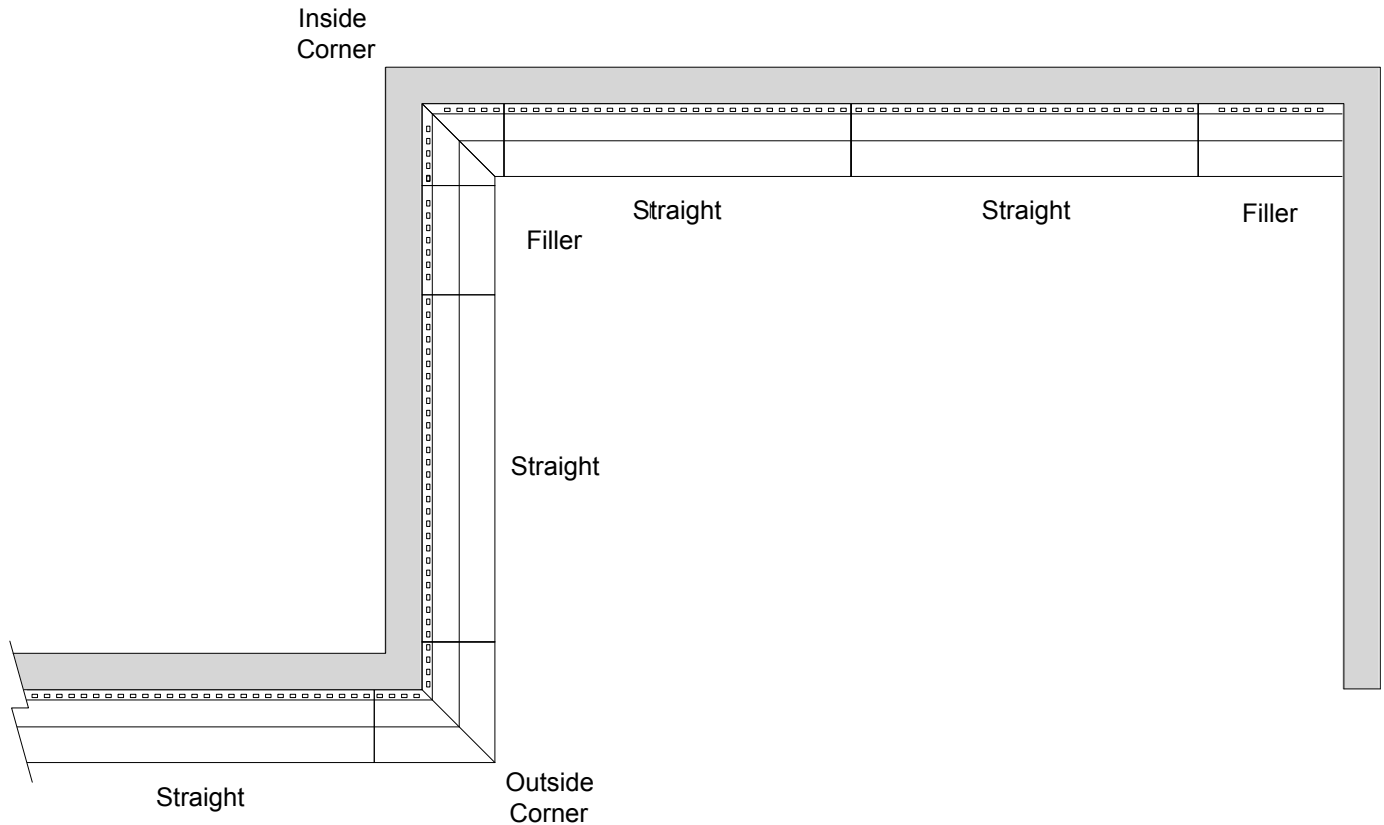

After installing mounting channels around the perimeter, place the corner fixtures, followed by straight fixtures. Trim the filler fixtures to fit remaining run lengths and place onto the mounting channel.

IMPORTANT: Provide finished layout to Bartco Lighting for verification.

To aid in producing layouts, visit www.bartcoLIGHTING.com/product/ADL210/layouttools/ for access to CAD blocks.

For detailed mounting instructions, visit www.bartcoLIGHTING.com/product/ADL210/install (coming soon!)